

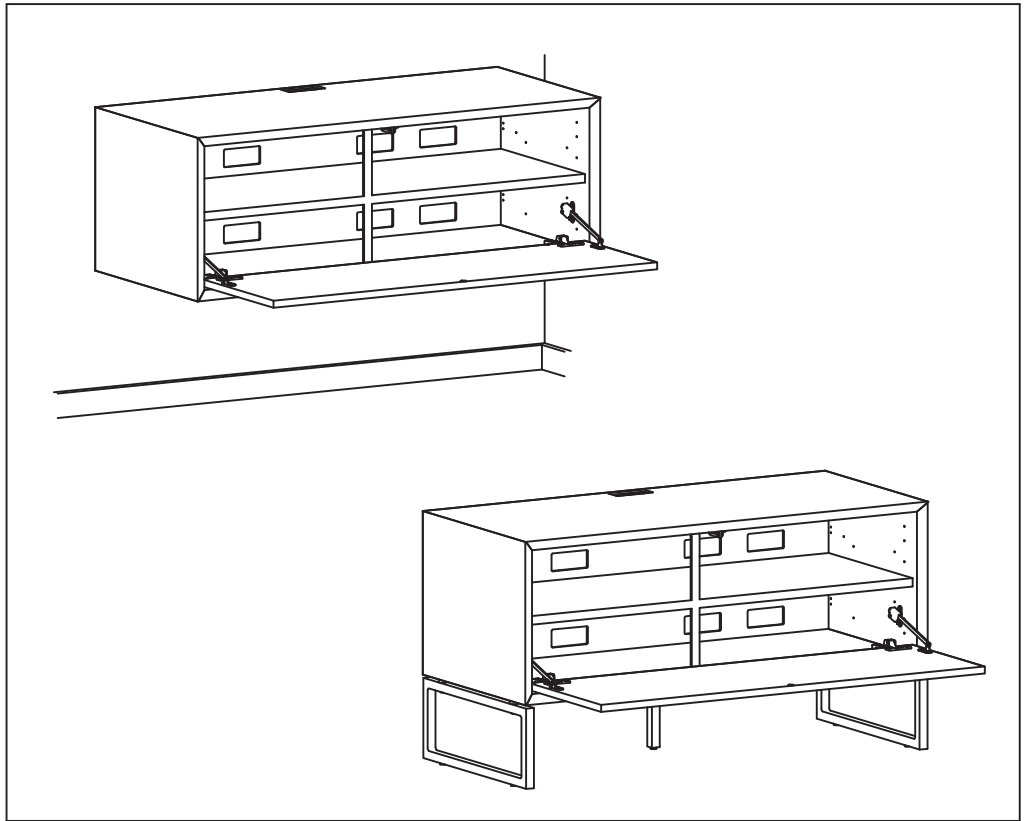

clíc support bars

Version 1.3



Beslag inkluderet
Fittings included
 Beschläge inbegriffen

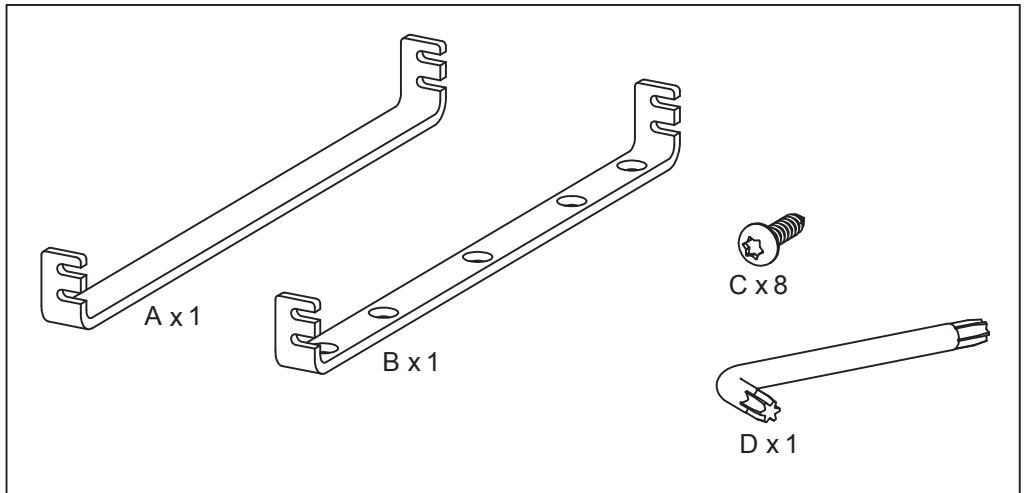

Nødvendige beslag
 (Ikke inkluderet)
Fittings needed
 (Not included)
 Geeignetes Montage-
 material (Nicht im Liefe-
 rumfang enthalten)

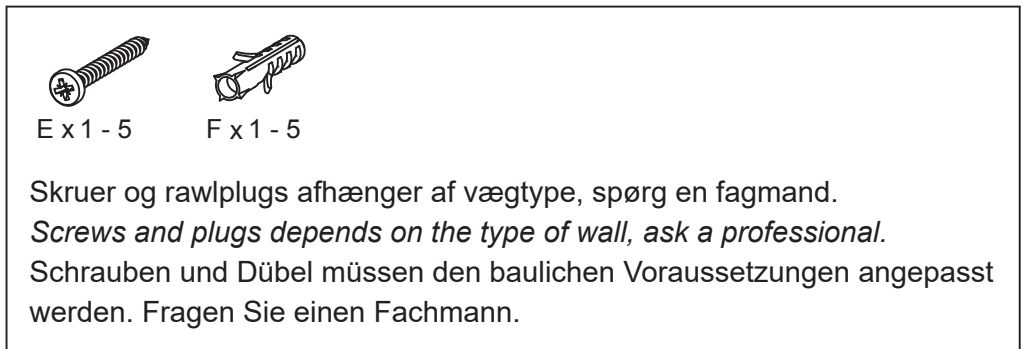

Nødvendigt værktøj
Tools needed
 Benötigte Werkzeuge

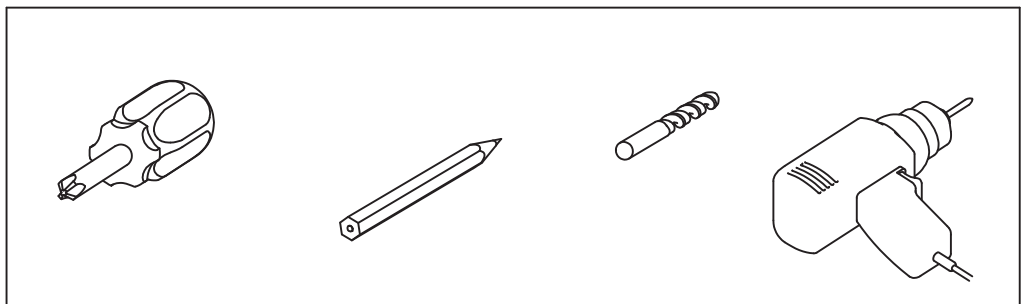

Support Bars

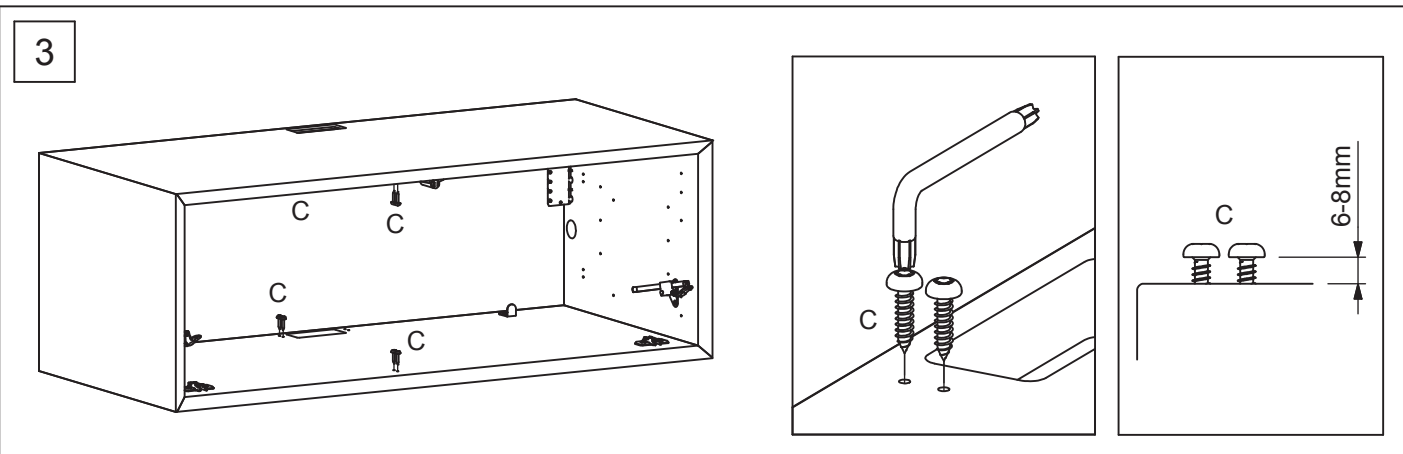
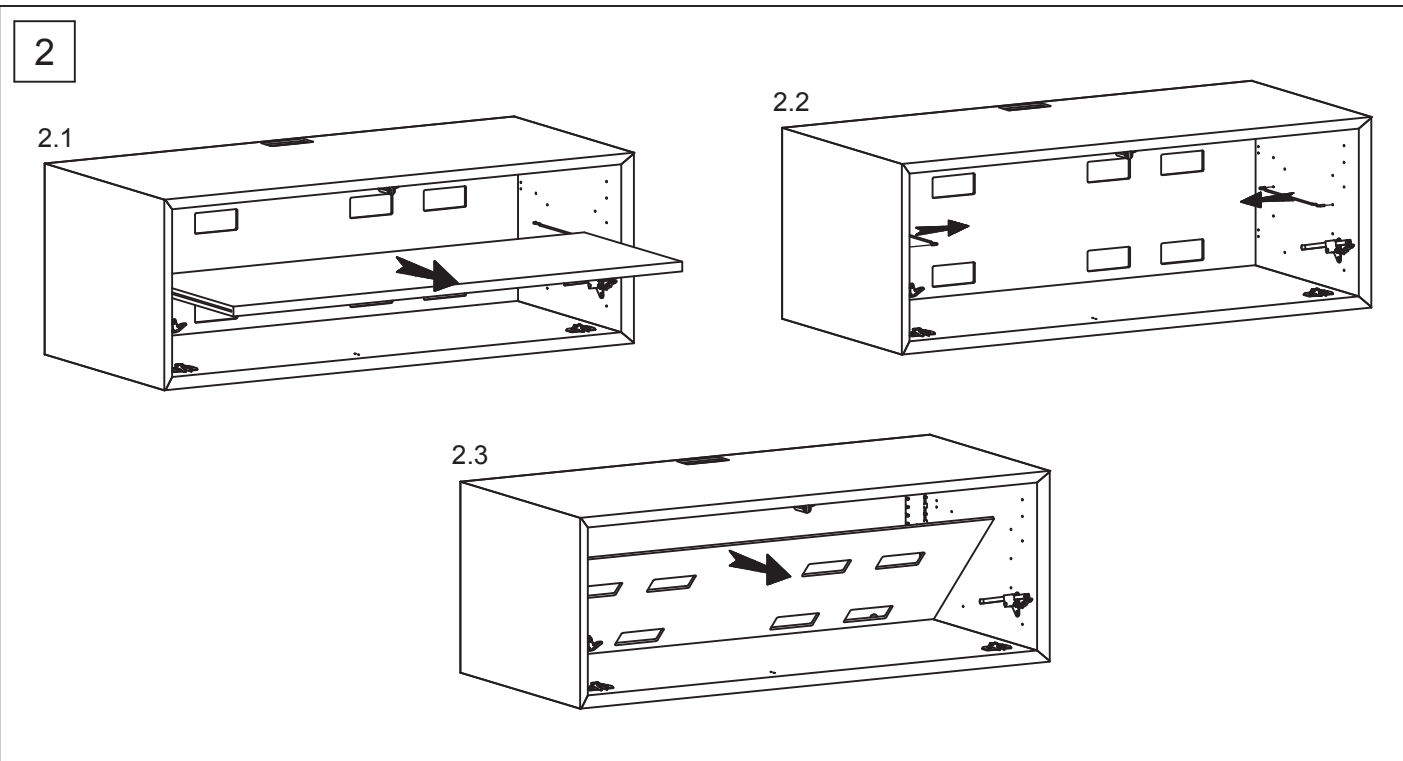
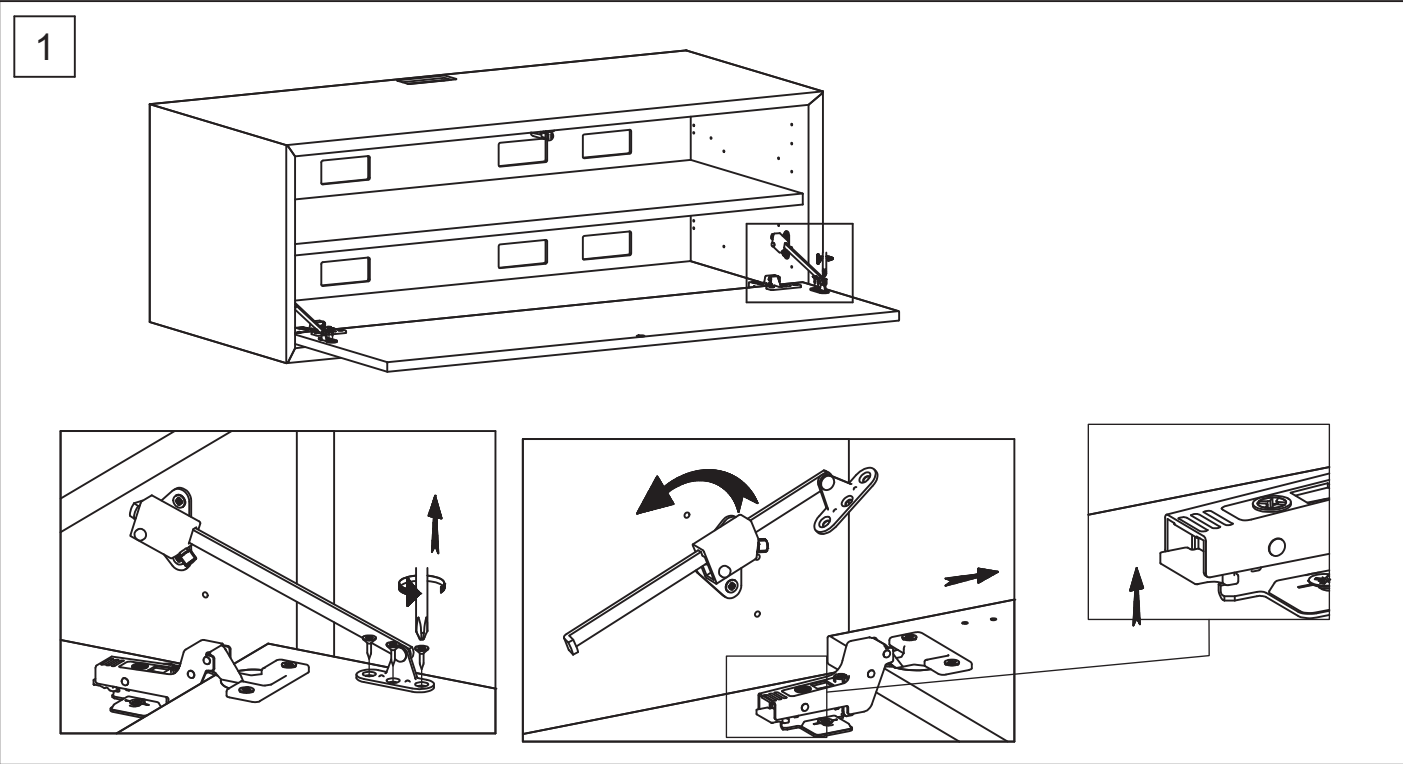

Support Bars

4

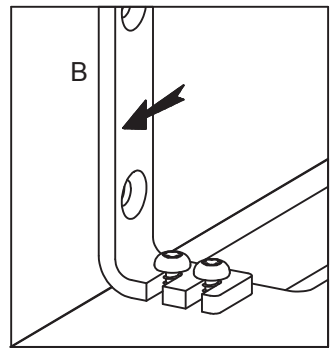
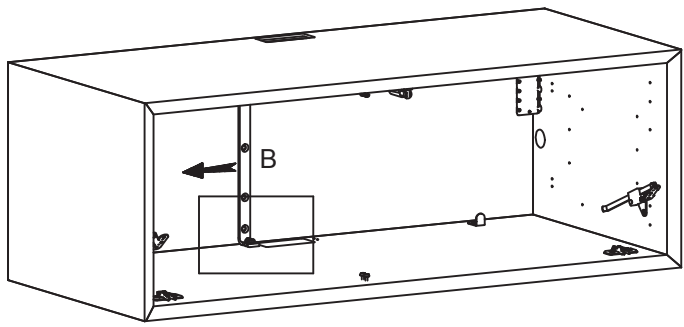

Hvis clic møblet skal placeres på ben eller hjul, venligst gå da videre til billede 6.
If the clic furniture is to be placed on stands or wheel, please proceed to picture number 6.
 Wenn das Möbel auf Standfüße oder Rädern platziert wird, bitte zum Bild 6 gehen.

5

Det er vigtigt at dit møbel er spændt fast og i water inden du går i gang.
It is important that your furniture is fastened to the wall and horizontally aligned before you begin.
 Es ist wichtig, dass Ihre Möbel an der Wand befestigt und horizontal ausgerichtet, bevor Sie beginnen.

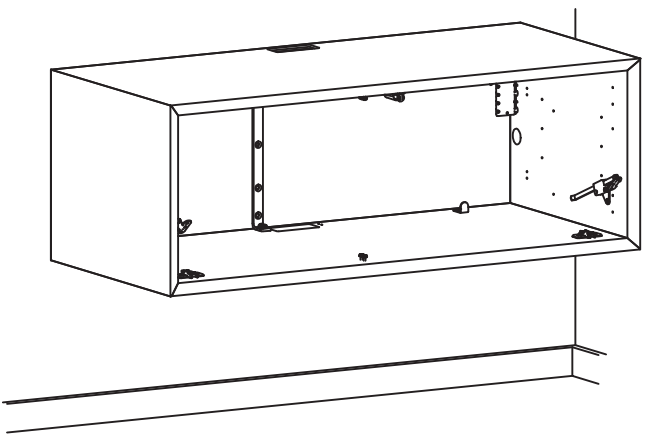

5.1

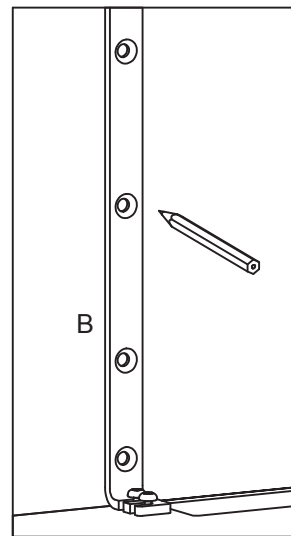

5.2

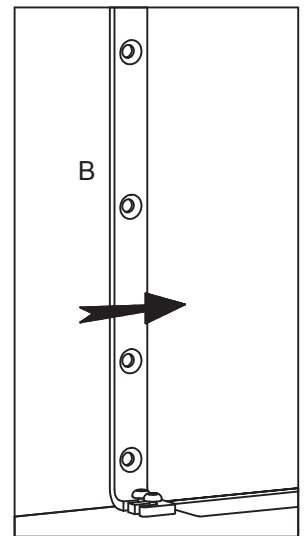

5.3

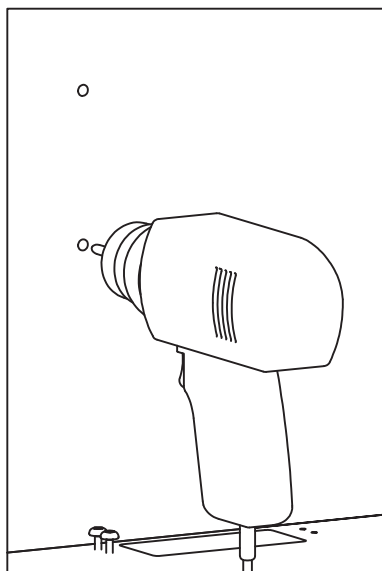

5.4

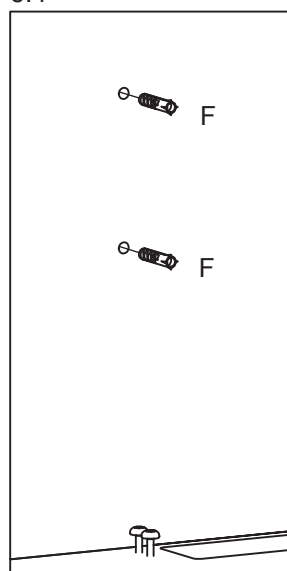

5.5

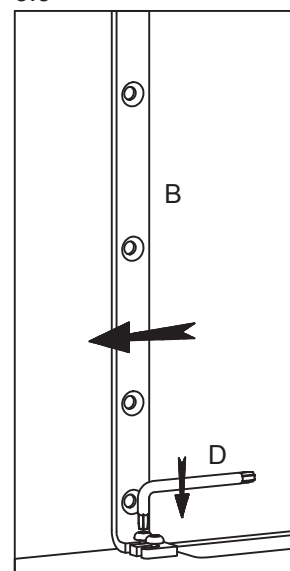

5.6

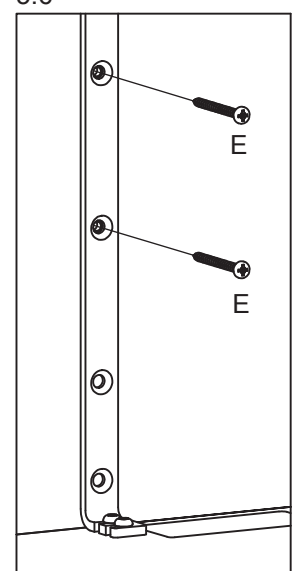

Support Bars

6

6.1

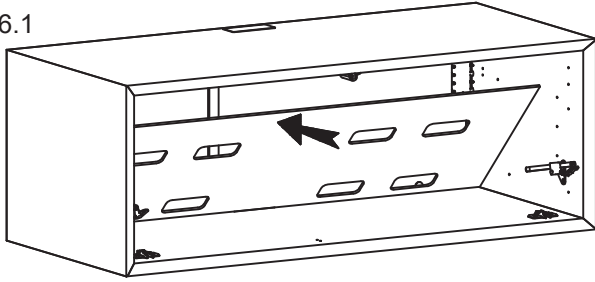

6.2

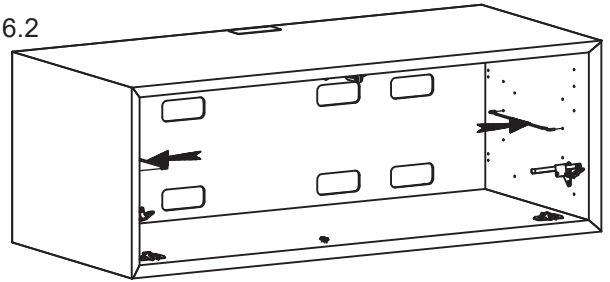

6.3

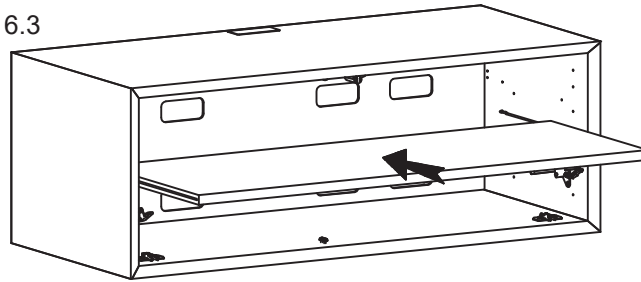

7

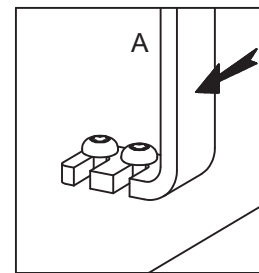
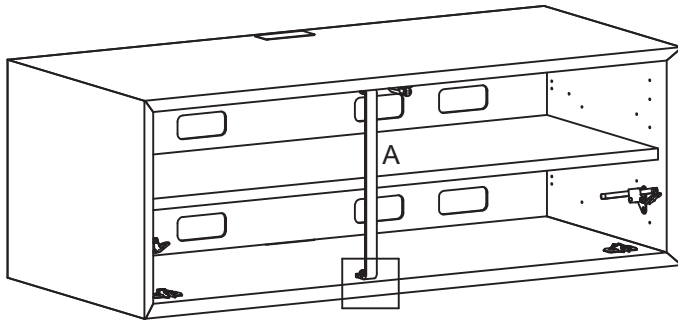

8

