

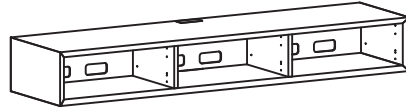

## clíc Wall bracket 3

Version 2.3



13S / 130 / 130S / 131 / 131S

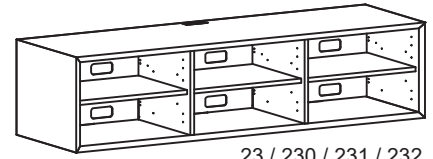

23 / 230 / 231 / 232

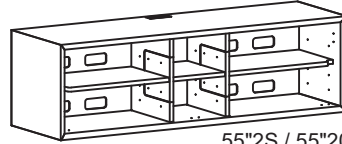

55"2S / 55"20S

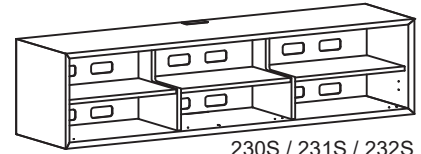

230S / 231S / 232S

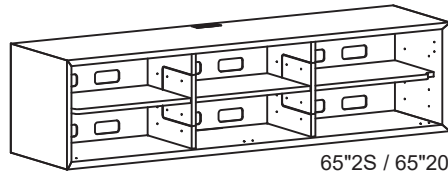

65"2S / 65"20S

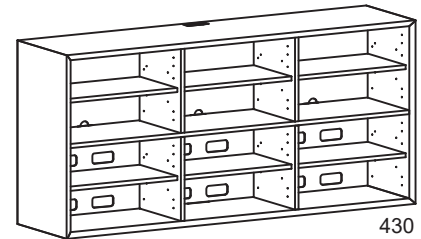

430

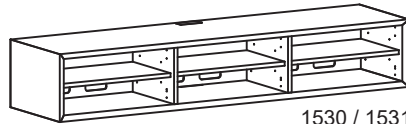

1530 / 1531

Beslag inkluderet  
Fittings included  
Beschlage inbegriffen

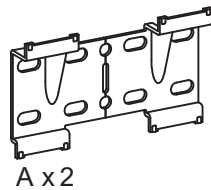

A x 2

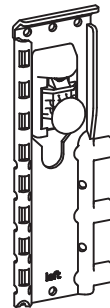

B x 2

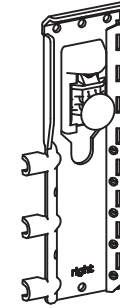

C x 2



D x 20

Nodvendige beslag  
(Ikke inkluderet)  
Fittings needed  
(Not included)  
Geeignetes Montage-  
material (Nicht im Liefere-  
umfang enthalten)



E x 8



F x 8

Skruer og rawlplugs afhanger af vegtype, sporg en fagmand.  
Screws and plugs depends on the type of wall, ask a professional.  
Schrauben und Dubel mussen den baulichen Voraussetzungen angepasst  
werden. Fragen Sie einen Fachmann.

Nodvendigt verktoj  
Tools needed  
Benotigte Werkzeuge

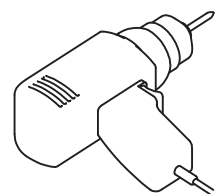
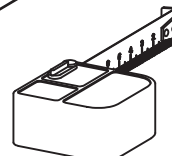
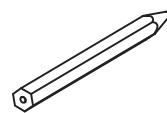
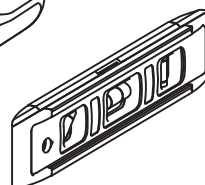
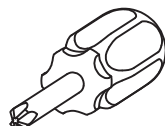

Maksimal belastning  
 Maximum Load  
 Maximale Belastung

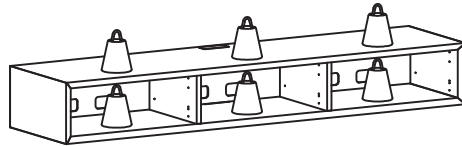

clic 13S = 50kg  
 clic 130 = 50kg  
 clic 131 = 40kg  
 clic 130S = 50kg  
 clic 131S = 40kg

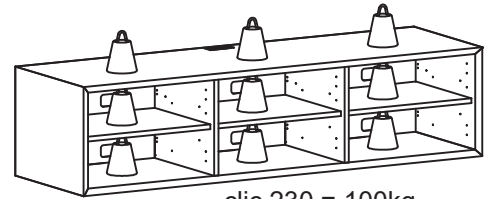

clic 230 = 100kg  
 clic 231 = 100kg  
 clic 232 = 100kg

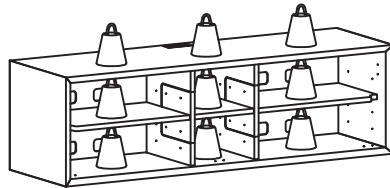

clic 55''2S = 60kg  
 clic 65''2S = 60kg  
 clic 55''20S = 60kg  
 clic 65''20S = 60kg

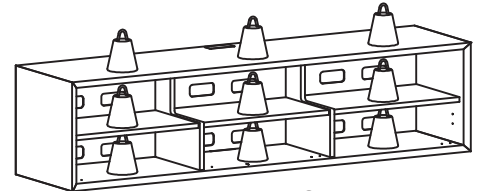

clic 230S = 70kg  
 clic 231S = 70kg  
 clic 232S = 70kg

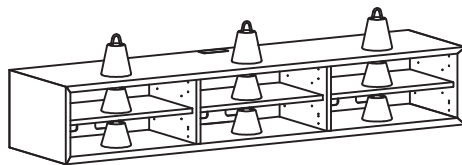

clic 1530 = 80kg  
 clic 1531 = 80kg

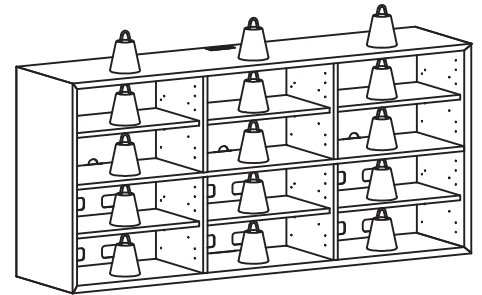

clic 430 = 100kg

1

1.1

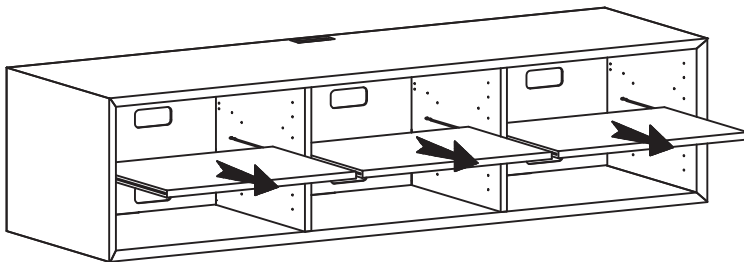

1.2

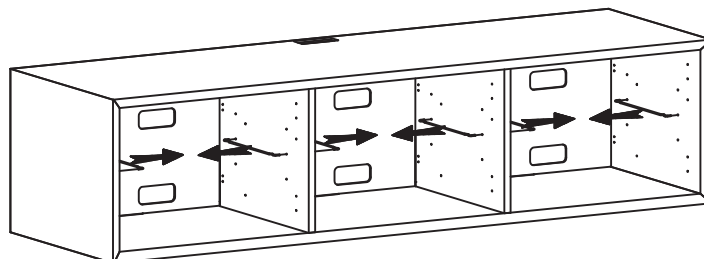

1.3

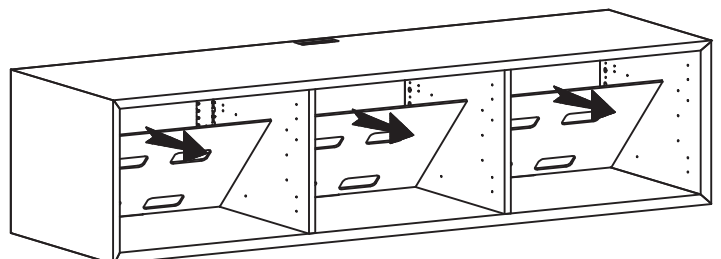

2

**130, 131**  
**13S, 130S, 131S**  
**23, 230, 231, 232**  
**230S, 231S, 232S**  
**430**

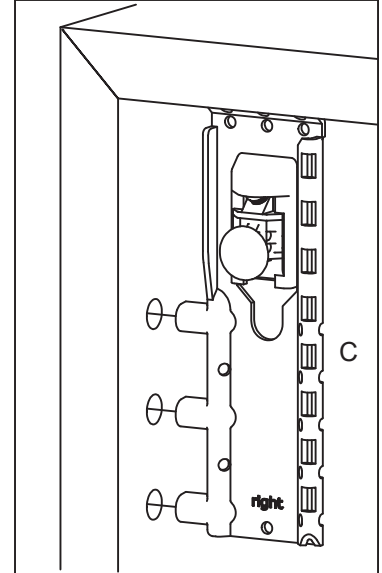
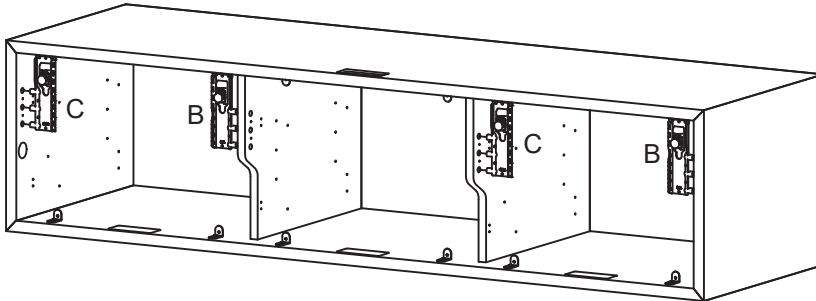

**55"2S, 55"20S**  
**65"2S, 65"20S**

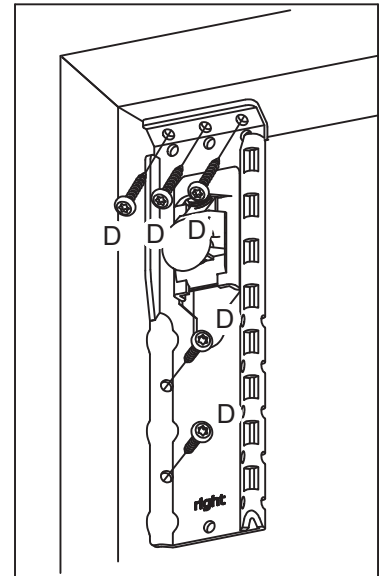
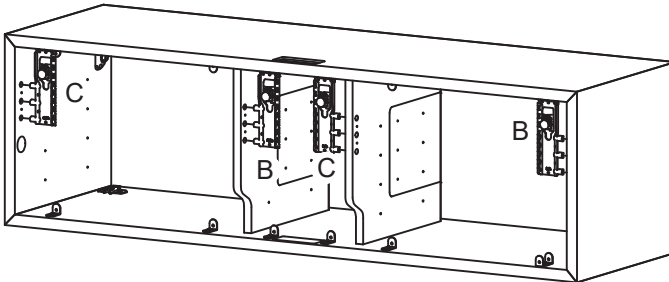

Pas på ikke at overspænde skruerne.  
*Be careful not to over-tighten the screws.*  
 Achten Sie darauf, die Schrauben nicht zu stark anzuziehen.

3

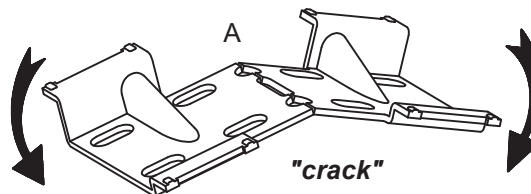

4

**130, 131**  
**13S, 130S, 131S**  
**23, 230, 231, 232**  
**230S, 231S, 232S**  
**430**

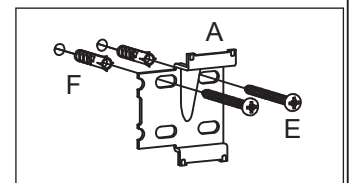
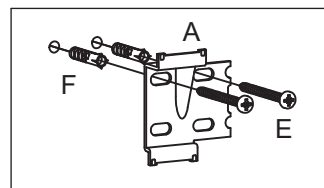
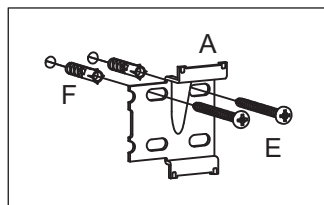
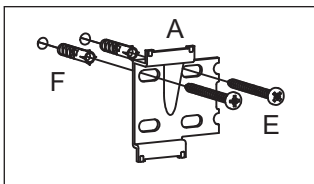
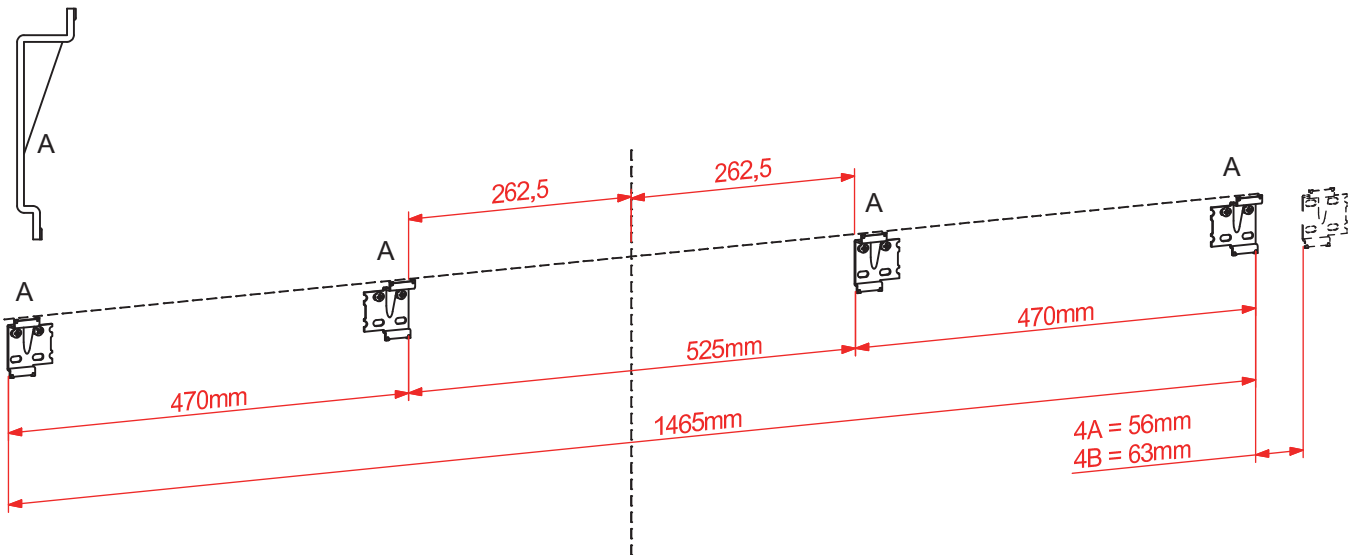
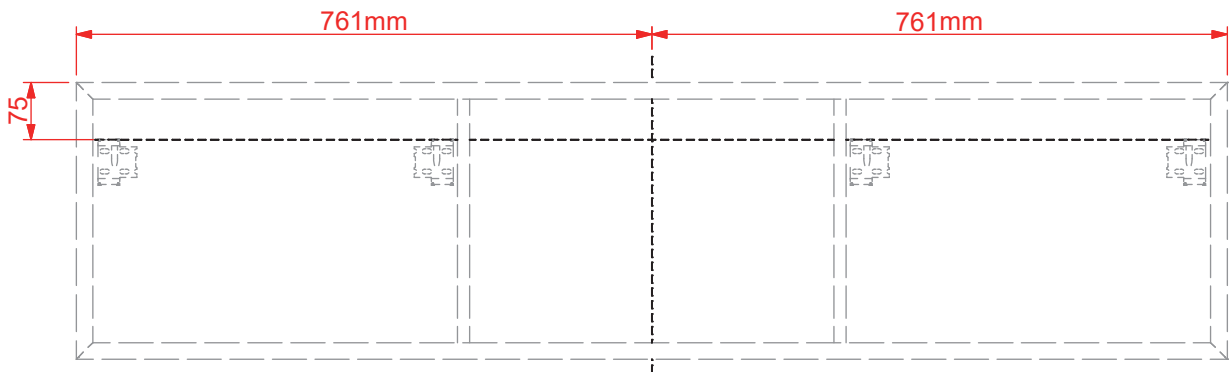
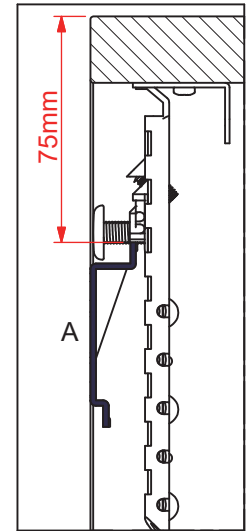
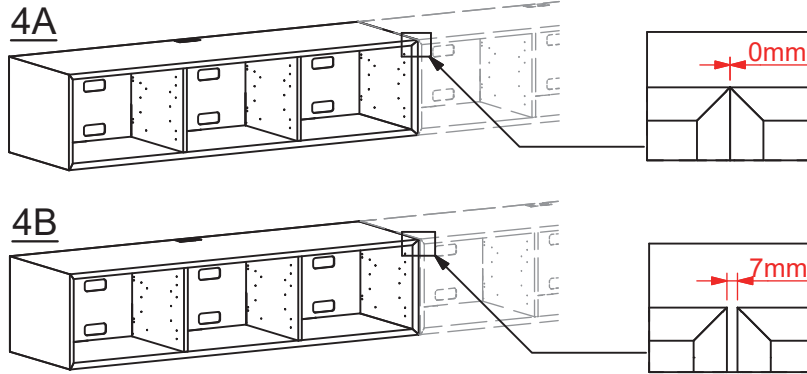

**5** **55"2S, 55"20S**

5A

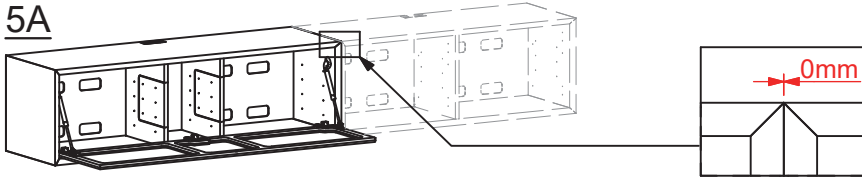

5B

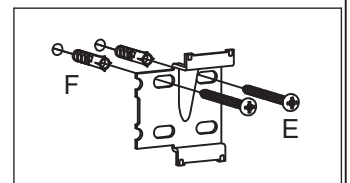
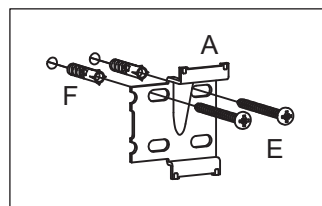
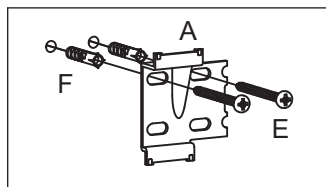
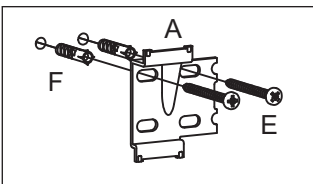
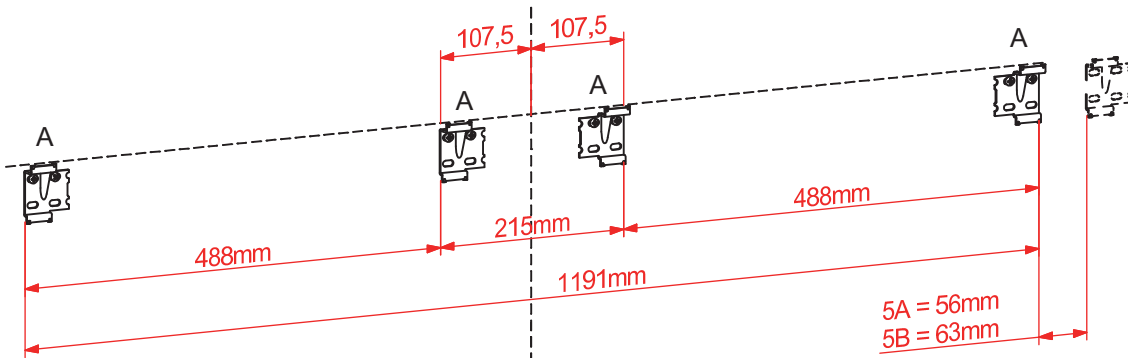
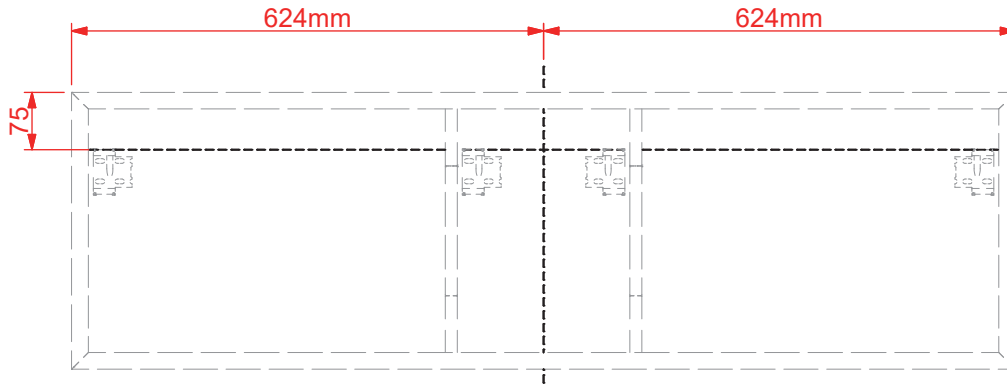
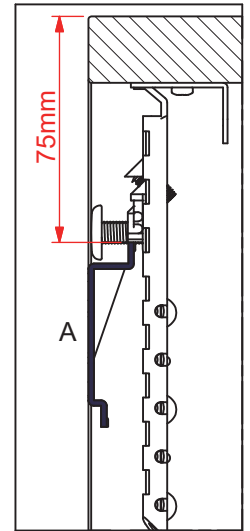
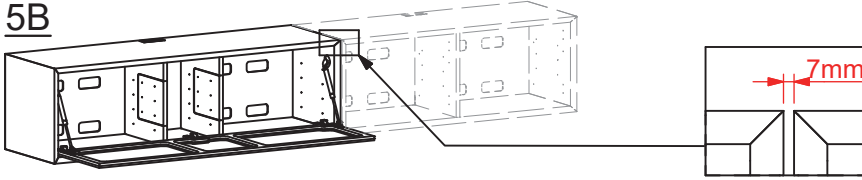

6

**65"2S, 65"20S**

6A

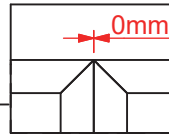
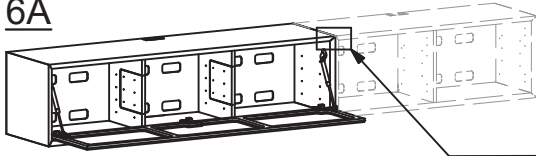

6B

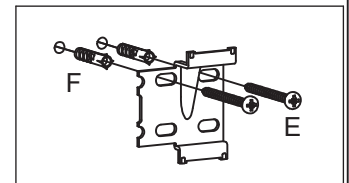
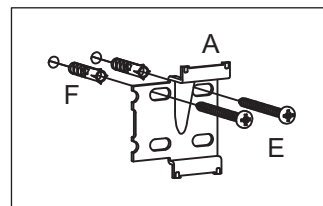
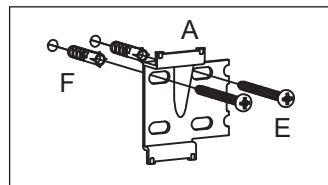
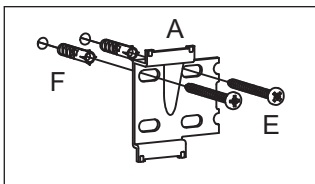
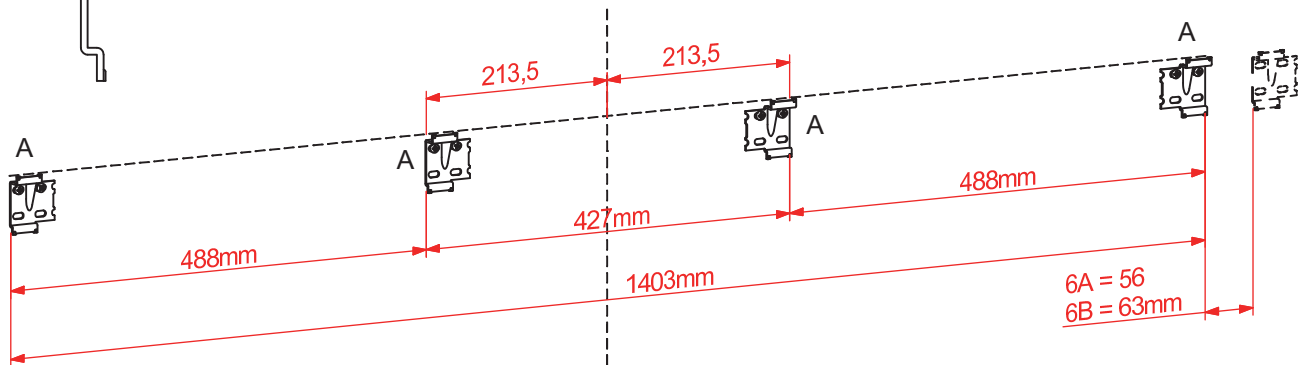
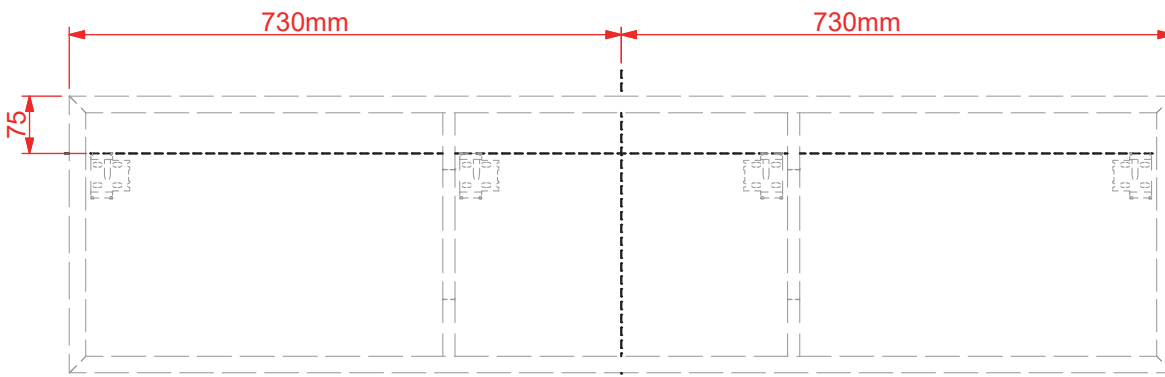
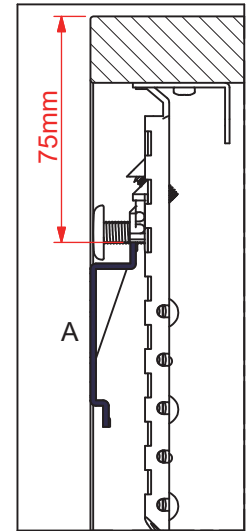
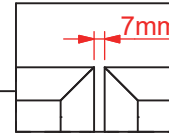
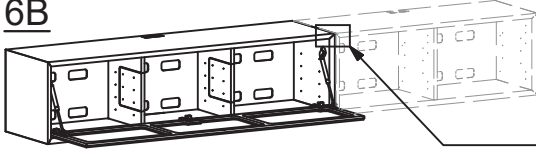

Wall Bracket 3

